

RD09

Nissan H233B,31 SPL**

****THIS MODEL WAS SUPERSEDED BY RD136, CROSSED OUT PARTS NOT AVAILABLE**

PARTS LIST

ITEM #	QTY	DESCRIPTION	PART #	NOTES
01	1	FLANGE CAP	020302	
02	1	CLUTCH GEAR	050202	
03	1	DIFFERENTIAL CASE	040306	
04	1	RETURN SPRINGS (PK OF 4)	150101SP	
05	1	RETAINING PIN SET (PK OF 4)	120303SP	
06	1	LONG CROSS SHAFT	060205	
07	2	SHORT CROSS SHAFT	060402	
08	1	PISTON	040202SP	
09	1	ANNULAR SEAL	160905SP	
10	1	CYLINDER CAP ASSEMBLY	030214	
11	1	CYL CAP RETAINING BOLT (PK OF 8)	200205SP	
12	1	LOCKING TAB (8mm) (PK OF 8)	150401SP	
13	1	TAPERED ROLLER BEARING	NOT SUPPLIED	
14	1	ADJUSTER NUT	100102SP	
15	1	SEAL HOUSING KIT	081902SP	
16	1	SEAL HOUSING O-RINGS (PK OF 2)	160235-2	1
17	1	SEAL HOUSING RETAINING CLIP	150601SP	
18	1	SPLINED SIDE GEAR	SEE NOTE	3
19	1	PINION THRUST WASHER(PK OF 4)	151102SP	
20	4	PINION GEAR	SEE NOTE	3
21	1	SPIDER BLOCK	070201SP	
22	1	THRUST BLOCK	110101SP	
23	1	SIDE GEAR	SEE NOTE	3
24	1	S GEAR THRUST WASHER (PK OF 2)	151002SP	
*	9	RING GEAR BOLT SPACER	4581061	2
*	1	BULKHEAD FITTING KIT (O-RING TYPE)	170111	
*	1	PUSH-IN FITTING (5mm to 1/8"BSPP)	170201SP	
*	1	AIR LINE (5mm DIA X 6m LONG)	170301SP	
*	1	SOLENOID VALVE (12V)	180103	
*	1	SWITCH FR OR RR LOCKER	180225	
*	1	CABLE TIE (PK OF 25)	180305	
*	1	OPERATING & SERVICE MANUAL	210200	
*	1	INSTALLATION GUIDE	210209	

* *Not illustrated in exploded view*

NOTES

- 1 For replacement O-rings use only BS133 Viton 75
- 2 If ring gear bolts are 10mm then spacers must be used (supplied with kit).
- 3 Available only as complete 6 gear set # 728A024
- For information on RD09 models with metal pistons, contact ARB.
- For seal housing set-up refer to tech notes (Section 5.1 & 5.2).
- For H233B 31 spline differential with no thrust block and no through cross shaft refer to RD78A (Section 2.78).

RD09

Nissan H233B,31 SPL**

****THIS MODEL WAS SUPERSEDED BY RD136, CROSSED OUT PARTS NOT AVAILABLE**

EXPLODED DIAGRAM

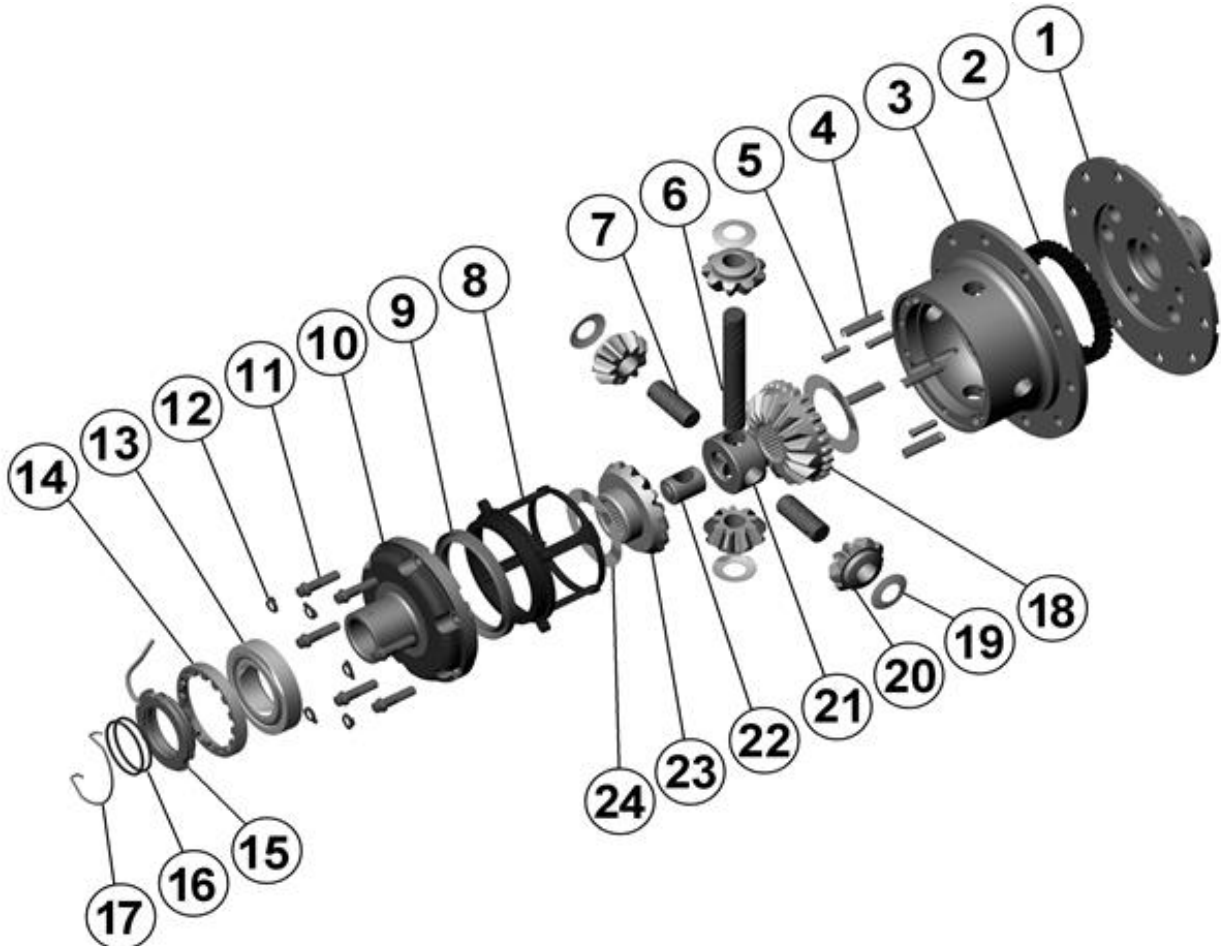

SPECIFICATIONS

Axle Spline	31 tooth, Ø32mm [1.26"]
Ratio Supported	All
Ring Gear ID	146.0mm [5.75"]
Ring Gear Bolts	9 bolts on Ø176mm [6.93"]
Ring Gear Bolt Size	12mm
Ring Gear Torque	142Nm [105 ft-lb]
Backlash	0.15-0.20mm [0.006-0.008"]
Bearing Cap Torque	99Nm [73 ft-lb]

ARB Corporation Ltd • 42-44 Garden St Kilsyth VIC 3137 Australia
ARB 4X4 Accessories USA • 4810 D St. NW #103 Auburn WA 98001 USA
Australia & International Customer Service • +61 3 9761 6622
North America Customer Service • Toll Free 866 293 9078
www.arb.com.au (AUS & Int) www.arbusa.com (N. America)

