

RD26

Land Rover HD,24 SPL**

****THIS MODEL IS NO LONGER IN PRODUCTION, CROSSED OUT PARTS ARE UNAVAILABLE**

PARTS LIST

ITEM #	QTY	DESCRIPTION	PART #	NOTES
01	1	FLANGE CAP	020404	
02	1	CLUTCH GEAR	050402	
03	1	DIFFERENTIAL CASE	010404	
04	1	RETURN SPRINGS (PK OF 4)	150101SP	
05	1	RETAINING PIN SET (PK OF 2)	120102SP	
*	1	RETAINING PIN SET (PK OF 2)	120302SP	
06	1	LONG CROSS SHAFT	060403	
07	2	SHORT CROSS SHAFT	060303	
08	1	PISTON	040103SP	
09	1	BONDED SEAL	160701SP	
10	1	CYLINDER CAP ASSEMBLY	030120	
11	1	CYL CAP RETAINING BOLT (PK OF 8)	200205SP	
12	1	LOCKING TAB (8mm) (PK OF 8)	150401SP	
13	1	TAPERED ROLLER BEARING	NOT SUPPLIED	
14	1	CLAMPING PLATE	090201	
15	1	SPLINED SIDE GEAR	SEE NOTE	2
16	1	PINION THRUST WASHER (PK OF 4)	151101SP	
17	4	PINION GEAR	SEE NOTE	2
18	1	SPIDER BLOCK	070404	
19	1	SIDE GEAR	SEE NOTE	2
20	1	S GEAR THRUST WASHER (PK OF 2)	151001SP	
21	1	ADJUSTER NUT (1.5mm thread pitch)	100201SP	
22	1	SEAL HOUSING KIT	080201SP	
23	1	SEAL HOUSING O-RINGS (PK OF 2)	160206-2	1
24	3	SEAL HOUSING SCREW	200501	
*	1	BULKHEAD FITTING KIT	170102	
*	1	PUSH-IN FITTING (5mm to 1/8"BSPP)	170201SP	
*	1	AIR LINE (5mm DIA X 6m LONG)	170301SP	
*	1	SOLENOID VALVE (12V)	180103	
*	1	SWITCH FR OR RR LOCKER	180225	
*	1	CABLE TIE (PK OF 25)	180305	
*	1	OPERATING & SERVICE MANUAL	210200	
*	1	INSTALLATION GUIDE	210226	

* *Not illustrated in exploded view*

NOTES

- 1 For replacement O-rings use only BS130 Viton 75.
- 2 Available only as complete 6 gear set # 728B064
- 5mm [3/16"] ring gear spacer plate (ARB part# 'RD03A') is available for use with early Land Rover 4.70:1 ratio gears but longer bolts must be used. (Land Rover part# 576521.)
- Refer to seal housing set-up tech note ([Section 5.1](#)).
- Refer to Land Rover axle update tech note for 10 to 24 spline conversion information ([Section 5.14](#)).
- For information on RD26 models with 4 cylinder cap bolts, contact ARB.

RD26

Land Rover HD,24 SPL**

****THIS MODEL IS NO LONGER IN PRODUCTION, CROSSED OUT PARTS ARE UNAVAILABLE**

EXPLODED DIAGRAM

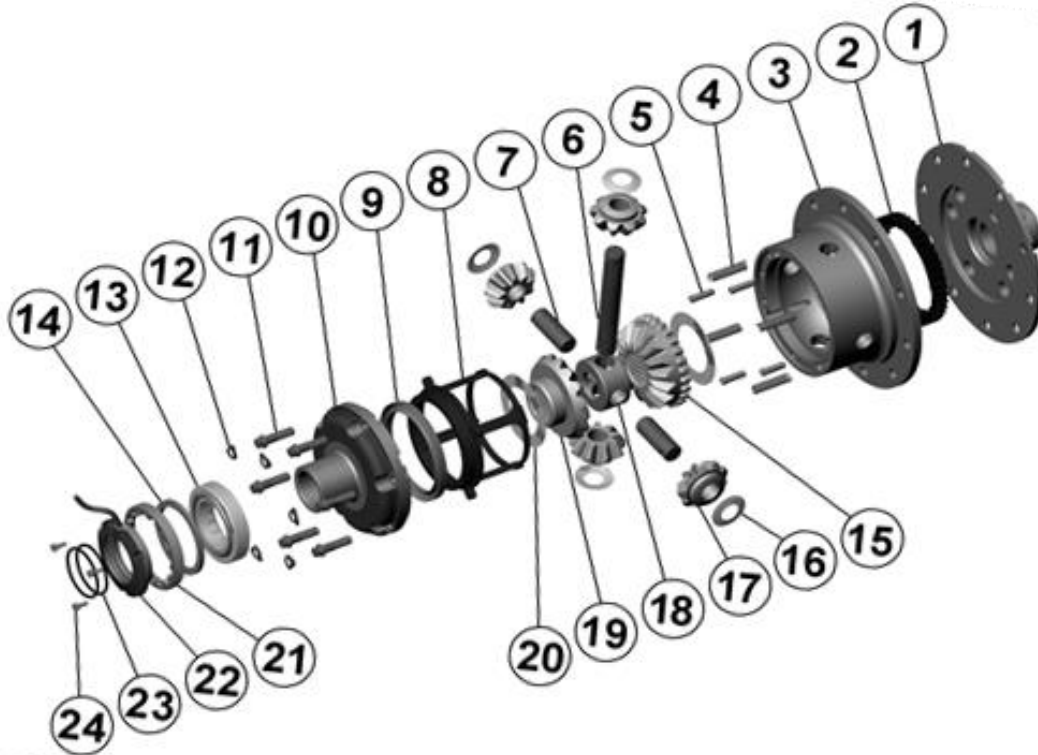

SPECIFICATIONS

Axle Spline	24 tooth, Ø31.5mm [1.24"]
Ratio Supported	3.54:1
Ring Gear ID	125.4mm [4.94"]
Ring Gear Bolts	10 bolts on Ø142mm [5.59"]
Ring Gear Torque	58Nm [43 ft-lb]
Backlash	0.10-0.17mm [0.004-0.007"]
Bearing Cap Torque	90Nm [66 ft-lb]

ARB Corporation Ltd • 42-44 Garden St Kilsyth VIC 3137 Australia
ARB 4X4 Accessories USA • 4810 D St. NW #103 Auburn WA 98001 USA
Australia & International Customer Service • +61 3 9761 6622
North America Customer Service • Toll Free 866 293 9078
www.arb.com.au (AUS & Int) www.arbusa.com (N. America)