

**RD51**

GM / AAM 9.25",33 SPL

**\*\*THIS MODEL WAS SUPERSEDED BY RD197, CROSSED OUT PARTS NOT AVAILABLE**

### PARTS LIST

ITEM #	QTY	DESCRIPTION	PART #	NOTES
01	1	FLANGE CAP	022404	
02	1	CLUTCH GEAR	050202	
03	1	DIFFERENTIAL CASE	042304	
04	1	RETURN SPRINGS (PK OF 4)	150101SP	
05	1	RETAINING PIN SET (PK OF 4)	120303SP	
06	1	LONG CROSS SHAFT	060205	
07	2	SHORT CROSS SHAFT	060402	
08	1	PISTON	040202SP	
09	1	ANNULAR SEAL	160905SP	
10	1	CYLINDER CAP	031404	
11	1	CYL CAP RETAINING BOLT (PK OF 8)	200205SP	
12	1	LOCKING TAB (8mm) (PK OF 8)	150401SP	
13	1	SEAL HOUSING O-RINGS (PK OF 2)	160239-2	1
14	1	SEAL HOUSING KIT	080903SP	
15	1	TAPERED ROLLER BEARING	NOT SUPPLIED	
16	1	SPLINED SIDE GEAR	SEE NOTE	2
17	4	PINION GEAR	SEE NOTE	2
18	1	PINION THRUST WASHER (PK OF 4)	151102SP	
19	1	SPIDER BLOCK	070201SP	
20	1	SIDE GEAR	SEE NOTE	2
21	1	S GEAR THRUST WASHER (PK OF 2)	151006SP	
*	1	SEAL HOUSING BRACKET (LIVE AXLE)	220203	
*	1	SEAL HOUSING BRACKET (IFS)	220204	
*	2	WASHER	4581072	
*	1	SOCKET HD CAP SCREW (M6 X 16mm)	200208	
*	1	BULKHEAD FITTING KIT (O-RING TYPE)	170111	
*	1	PUSH-IN FITTING (5mm to 1/8"BSPP)	170201SP	
*	1	AIR LINE (5mm DIA X 6m LONG)	170301SP	
*	1	SOLENOID VALVE (12V)	180103	
*	1	SWITCH FR LOCKER	180223	
*	1	CABLE TIE (PK OF 25)	180305	
*	1	OPERATING & SERVICE MANUAL	210200	
*	1	INSTALLATION GUIDE	210251	

\* *Not illustrated in exploded view*

### NOTES

- 1 For replacement O-rings use only BS146 Viton 75.
- 2 Available only as complete 6 gear set # 728A084
- Ring gear bolts are M12x1.5mm left-hand thread, and must be removed in a clockwise direction.
- Use extreme care to protect the sealing faces of the flange when separating the two halves of the clamshell housing.

**RD51**

GM / AAM 9.25", 33 SPL

**\*\*THIS MODEL WAS SUPERSEDED BY RD197, CROSSED OUT PARTS NOT AVAILABLE**

### EXPLODED DIAGRAM

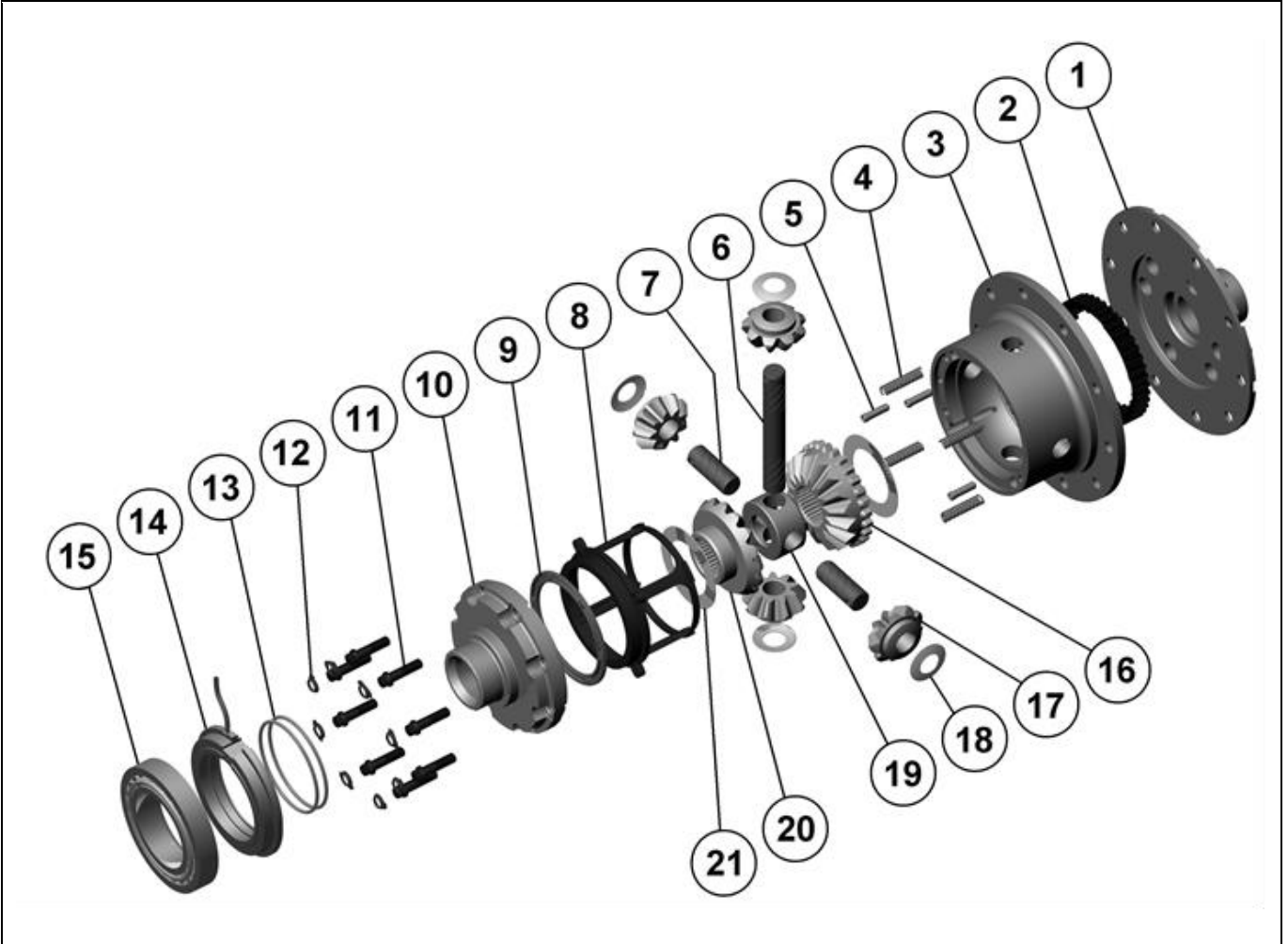

### SPECIFICATIONS

Axle Spline	33 tooth, Ø34.8mm [1.37"]
Ratio Supported	All
Ring Gear ID	152.9mm [6.02"]
Ring Gear OD	235mm [9.25"]
Ring Gear Bolts	12 bolts on 181mm [7.13"]
Ring Gear Torque	88Nm [65 ft-lb]
Backlash	0.15-0.25mm [0.006-0.010"]

ARB Corporation Ltd • 42-44 Garden St Kilsyth VIC 3137 Australia  
ARB 4X4 Accessories USA • 4810 D St. NW #103 Auburn WA 98001 USA  
Australia & International Customer Service • +61 3 9761 6622  
North America Customer Service • Toll Free 866 293 9078  
www.arb.com.au (AUS & Int) www.arbusa.com (N. America)

