

**RD152**

Toyota 9.5",32 SPL

### PARTS LIST

ITEM #	QTY	DESCRIPTION	PART #	NOTES
01	1	FLANGE CAP KIT	027323SP	
02	1	BONDED SEAL	160702SP	
03	1	CLUTCH GEAR & WAVESPRING KIT	050906SP	
04	2	SHORT CROSS SHAFT	060403SP	
05	1	LONG CROSS SHAFT	060204SP	
06	1	SIDE GEAR	SEE NOTE	3
07	2	SIDE GEAR THRUST WASHER	SEE NOTE	4
08	1	COUNTERSUNK SCREW (PK OF 2)	200213SP	
09	1	RETAINING PIN SET (PK OF 4)	120601SP	
10	-	TAPERED ROLLER BEARING	NOT SUPPLIED	2
11	1	SEAL HOUSING RETAINING CLIP	150601SP	
12	1	SEAL HOUSING KIT	081901SP	
13	1	SEAL HOUSING O-RINGS (PK OF 2)	160207-2	1
14	1	ADJUSTER NUT	100101SP	
15	1	WAVESPRING	150706SP	
16	1	SPLINED SIDE GEAR	SEE NOTE	3
17	4	PINION GEAR	SEE NOTE	3
18	4	PINION THRUST WASHER	SEE NOTE	4
19	1	SPIDER BLOCK	070201SP	
20	1	DIFFERENTIAL CASE	013023SP	
*	1	BULKHEAD FITTING KIT (BANJO TYPE)	170114	5
*	1	AIR LINE (6mm DIA X 6m LONG)	170314	5
*	1	SOLENOID VALVE (12V)	180103	
*	1	SWITCH RR LOCKER	180224	
*	1	CABLE TIE (PK OF 25)	180305	
*	1	OPERATING & SERVICE MANUAL	210200	
*	1	INSTALLATION GUIDE	2102152	

\* *Not illustrated in exploded view*

### NOTES

- 1 For replacement O-rings use only BS136 Viton 75.
- 2 For replacement Bearings use Timken Bearing #32010X (ARB# 160116).
- 3 Available only as complete 6 gear set # 728H201
- 4 Available only as complete thrust washer kit #730H01
- 5 All diffs produced before serial #17070001 came with 5mm air connection system. For information contact ARB.
- Refer to seal housing set-up tech note ([Sec. 5.2](#)).
- Refer to pinion modification tech note ([Sec. 5.6](#)).

**RD152**

Toyota 9.5",32 SPL

### EXPLODED DIAGRAM

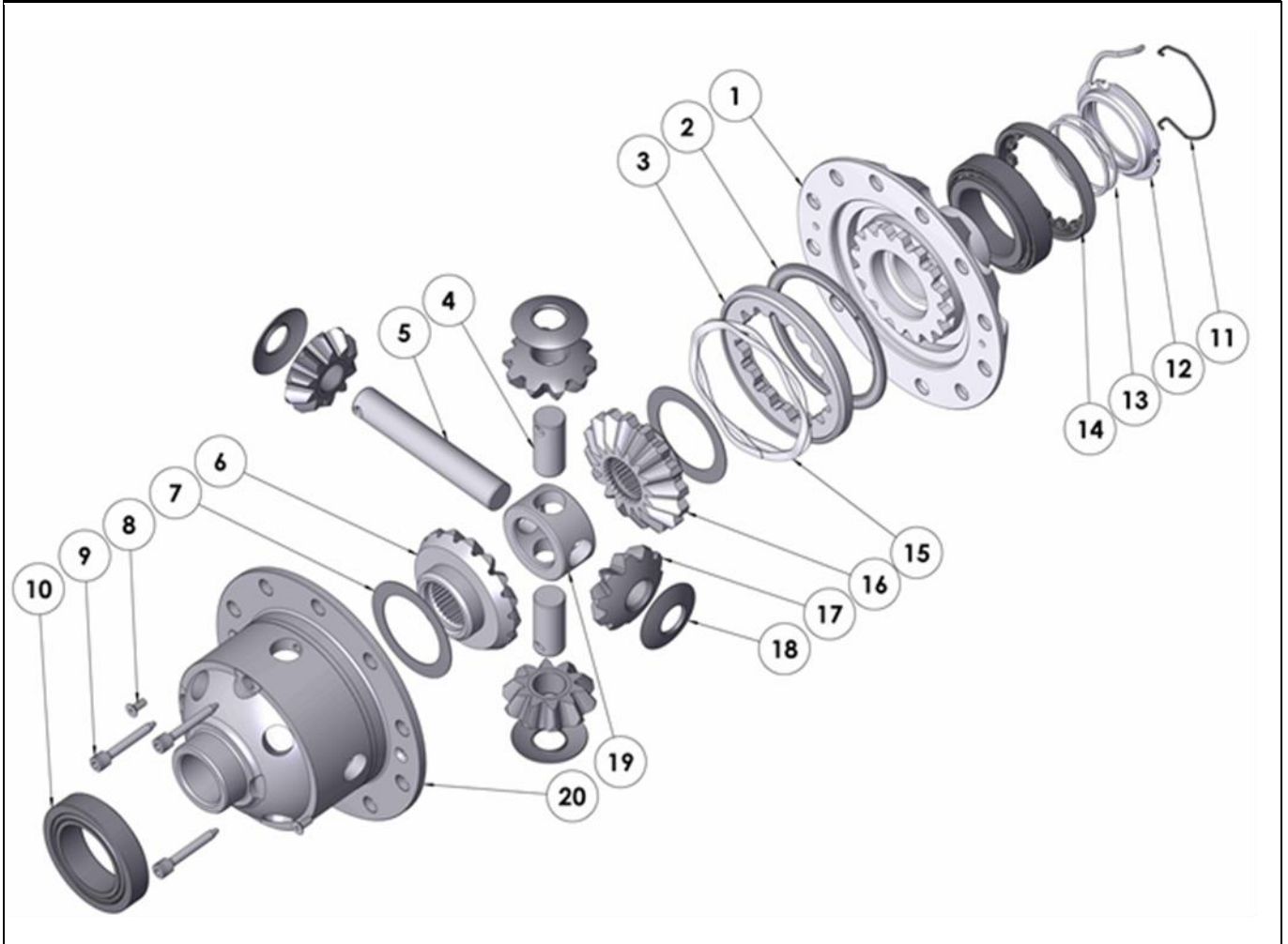

### SPECIFICATIONS

Axle Spline	32 tooth, Ø34.8mm [1.37"]
Ratio Supported	All
Ring Gear ID	150.0mm [5.91"]
Ring Gear OD	241mm [9.5"]
Ring Gear Bolts	12 bolts on Ø174mm [6.85"]
Ring Gear Torque	95Nm [70 ft-lb]
Backlash	0.15-0.25mm [0.006-0.010"]
Bearing Cap Torque	95Nm [70 ft-lb]